

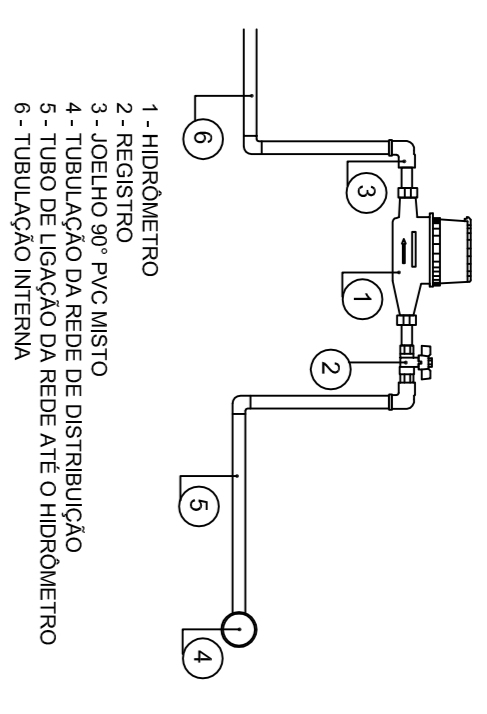





Detalhes da Ligação da Rede até o Hidrômetro

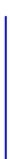

LEGENDA

-  Tubo PVC Soldável CL15 DE 20mm
-  Tubo PVC Soldável CL15 DE 25mm
-  Tubo PVC Soldável CL15 DE 32mm
-  Tubo PVC Soldável CL15 DE 40mm
-  Tubo PVC Soldável CL15 DE 50mm
-  Tubo PVC Soldável CL15 DE 60mm

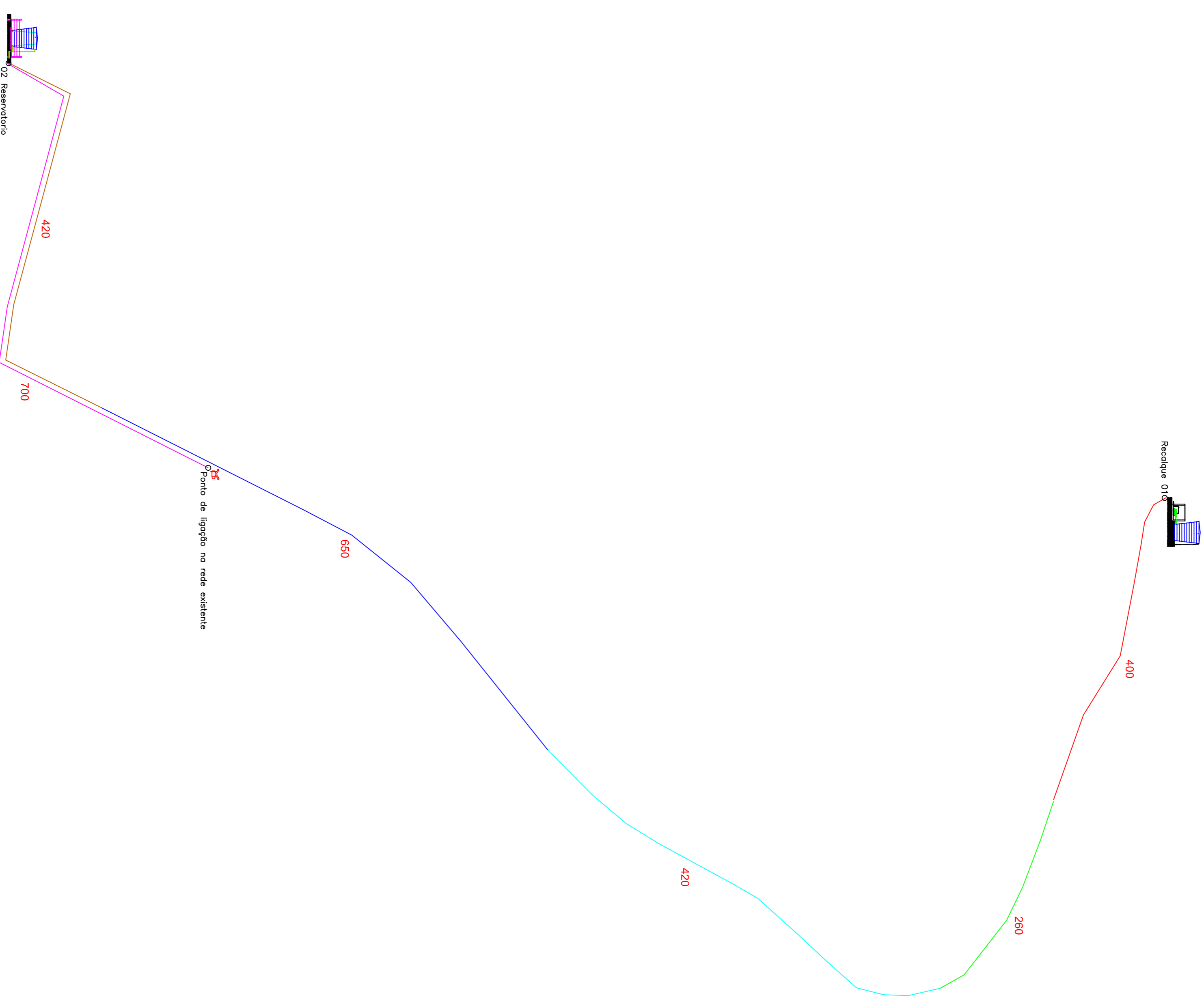
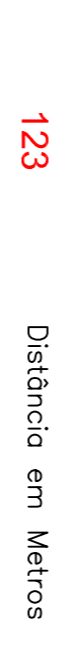
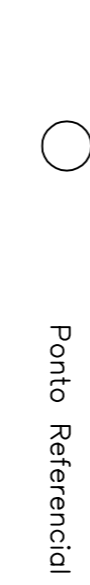
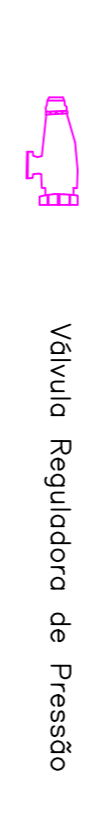
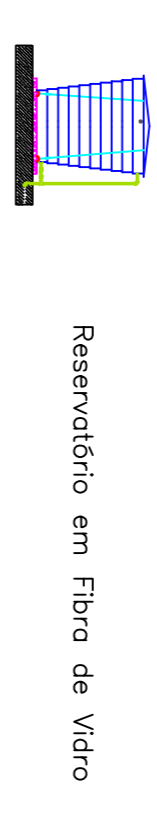

02 Reservatório

Recipiente 010

Ponto de ligação na rede existente

Interessado: **Município de Flor do Sertão /SC**

Obra: **Sistema de Abastecimento de Água**

RESP. TÉCNICO:

Detalhes: **Área Necessária**

Escala: **Indicada/Metros** Data: **setembro2017** Prancha: **01/03**

Observação: **Sede do Município a Area Industrial**